

















GV66260

gorenje
Life Simplified

Fully integrated dishwasher



-  16 place settings
-  15min SpeedWash
-  TotalDry
-  SmartFlex
-  SmartControl
-  Adjustable baskets
-  AutoProgramme
-  ExtraHygiene
-  SmartLook
-  Status LedLight
-  XXL inox
-  Total AquaStop
-  Hot water connection
-  SelfCleaning filter
-  StartDelay
-  QuickIntensive

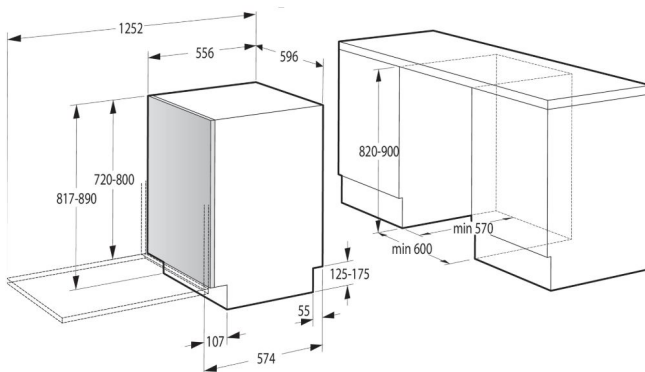

Energy class: **A+++**

Max. temperature of incoming water: **70 °C**

Motor: **Asynchronous single phase motor**

Selected programme indicator

Control: **TouchControl**

Status light™

Sensors: **Clear water sensor, Load sensor**

Main Washing temperature(s): **70, 65, 55, 45, 35 °C**

5 programmes: Automatic programme; Intensive programme; Eco programme; Rinsing; Quick programme 20

Reference programme: **3**

16 place settings

Memory programme

QuickIntensive programme

Automatic programme

SpeedWash function

TotalDry – automatic door opening

ExtraHygiene

Function 3 in 1

Selected programme indicator

Visual indicator for wash finish on control panel

Voice signal for the end of washing cycle

Time remaining indicator: **Time remaining indicator**

Door panel installation options: **Possible as extra**

Up to 24 hours

Number of baskets: **3**

Net weight: **35.5 kg**

Upper basket system: **MultiClack**

Gross weight: **38.1 kg**

Foldable bottom plate baskets

Consumption in standby mode: **0.49 W**

Number of water jet levels: **5**

Connected load: **1,900 W**

Number of spray arms: **3**

Nominal current of fuse: **10 amp**

Selfcleaning filter

Product code: **538907**

Sliding door

EAN code: **3838942110016**

Upper basket: **Wide mesh base; Handle with plastic logotype; Foldable left CupHolder; Foldable right CupHolder; Wide knife stand; One foldable glass support**

Lower basket: **Wide mesh base; Handle with stainless steel logotype; Foldable/divisible rear pin row**

Top tray: **With telescopic rails; Handle with stainless steel logotype**

Overflow protection: **Total AquaStop**

Service diagnostics

Stainless steel tub

Water consumption: **9.5 l**

Energy consumption - label program: **0.86 kWh**

Estimated annual water consumption: **2,660 l**

Noise level: **45 dB(A)re 1 pW**

Height setting: **70 mm**

Dimensions (W×H×D): **59.6 × 81.7 × 55.6 cm**

Dimensions of packed product (W×H×D): **64 × 89 × 66.5 cm**

Niche dimensions (W×H×D): **60 × 82 × 57 cm**



<https://eg.gorenje.com/en/product/538907>